



Tire Service International, LLC

3451 S. 40TH ST.
PHOENIX, AZ 85040

Office: 602.437.5020

Email: sales@buysi.com

Fax: 602.437.5025

525 TIRE SPINNER

REPAIR PARTS BOM

October 2021

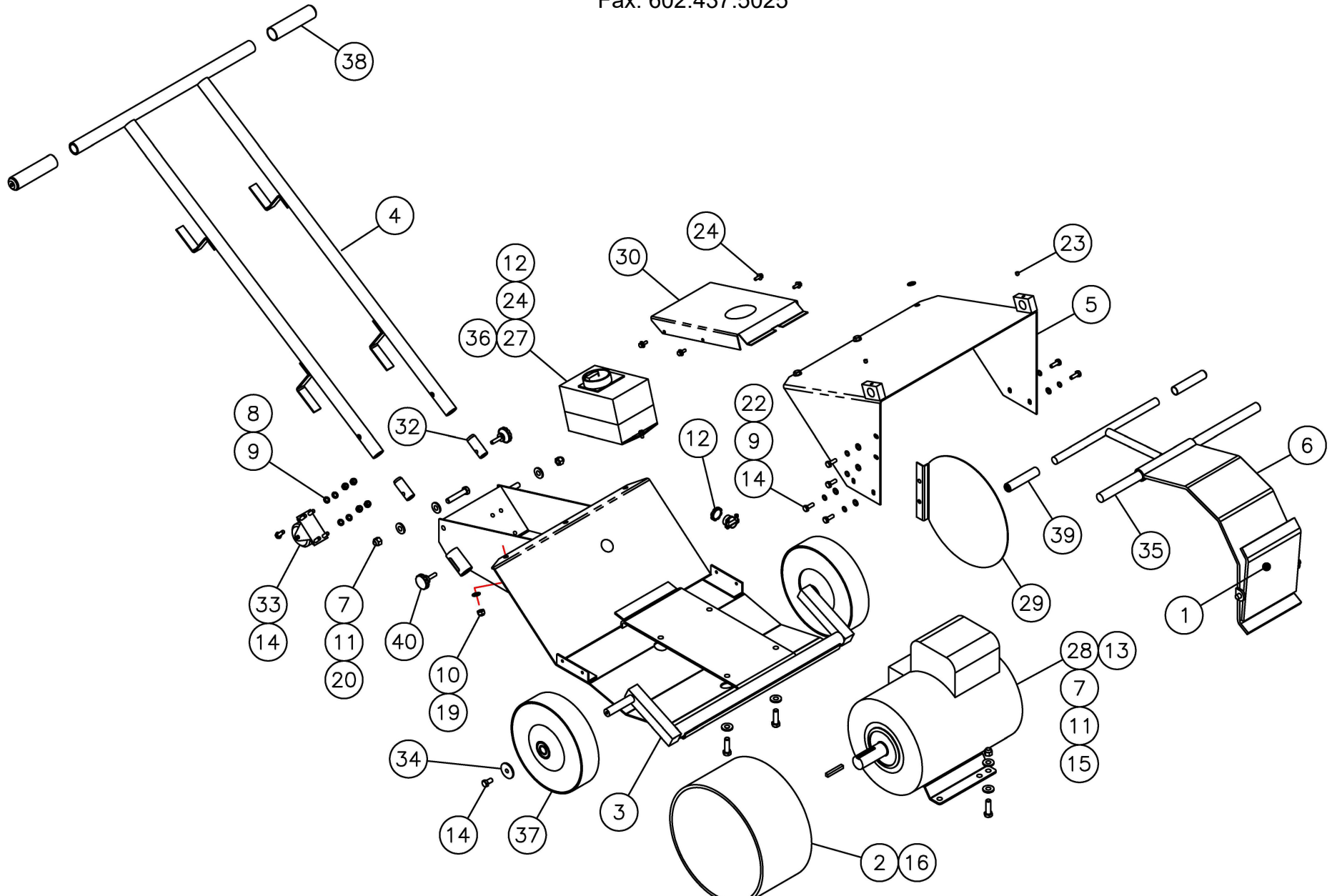



TIRE SERVICE INTERNATIONAL

buyTSI.com - 800.223.4540

525 TIRE SPINNER

REPAIR PARTS BOM

October 2021

PARTS LIST			
ITEM	PART NO.	DESCRIPTION	QTY
1	6251	BRAKE WELD	1
2	6255	WHEEL, ROLLER	1
3	6256	BASE, AXLE	1
4	6338	HANDLE, WELD	1
5	6357	FENDER COVER, WELD	1
6	6358	BRAKE, WHEEL STOP	1
7	212 N	NUT 3/8-16 HEX NYLOK	6
8	226-N	NUT 1/4-20 NYLOK	4
9	445	WASHER 1/4 FLAT	6
10	566	NUT 5/16-18 NYLOK	3
11	12758	WASHER 3/8 WROUGHT	10
12	3515	ELEC FLEX CONNECT	4
13	12443	WIRE NUT IDEAL #74 YELLOW	3
14	12468	HHCS 1/4-20 X 3/4 GR2	12
15	447	HHCS 3/8-16 X 1.0	8
16	1308	SHSS 3/8-16 X 5/16 CUP POINT	2
17	1318	WASHER 5/16 WROUGHT	16
18	1354	WASHER 3/8 LOCK	2
19	1819	SELF TAP 1/4-20 X 3/4 WASHER HEAD	4
20	3404	HHCS 3/8-16 X 2	2
21	719	HHCS 3/8-16 X 1-1/2 GR5	2
22	4134	WASHER 1/4 SPRING LOCK PLATED	2
23	275.028	SHSS 1/4-20 X 1/4 CUP POINT PLAIN	2
24	4569	HWHST #10-24 X 3/4 TYPE 23 PLATED	6
25	4782	DECAL - SAFETY GLASSES	1
26	1737	HWHST 5/16 X 3/4	3
27	10678	SWITCH, 1 AND 3 PHASE	3
28	15048	MOTOR 5 HP, 3500 RPM, 208/230V 1PH	REF
	15049	MOTOR 7-1/2 HP, 3500 RPM, 208-460V 3PH	1
29	15080	COVER, ROLLER	1

PARTS LIST			
ITEM	PART NO.	DESCRIPTION	QTY
30	15081	COVER, CONTROLS	1
31	15160	DECAL - AMERMAC/STI LARGE	2
32	15251	SLIDE PIN, HANDLE	2
33	15254	WHEEL, ROLLER CASTER 2" OD	1
34	15329	WASHER, FENDER 3/8 X 1-1/2	2
35	15425	SHAFT, BRAKE BAR	1
36	15463	CORD 10/4 AWG	20'
37	15468	WHEEL, 8"OD X 2-1/2" WIDE	2
38	231	HANDLE, 1" Black	2
39	15470	HANDLE, 5 RED GRIP	2
40	15471	KNOB, HANDLE - PIN	2
41		DECAL - MADE IN USA	1
42			
43			
44			
45			
46			
47			
48			
49			
50			
51			
52			
53			
54			
55			
56			
57			
58			
59			